

RAPID PRO

Installation & User Manual



Quick Reference

Record your details here:

Model No:

Serial No:

Purchase Date:

Installer:

Warranty Registered Online: Yes / No Date Registered / /20

Please record the information below during installation as this will be required for any service or warranty related work that may be required.

Please contact your local distributor or contact Oasis directly and we will either direct you to your nearest authorised repairer for assistance.

New Zealand contact details can be found at oasisheatpumps.com

Or email us at service@oasisheatpumps.com





Table of Contents

1	Quick Reference
3	Introduction
4	Important Things to Note
5	Specifications
7	Modes / Codes
8	Quick Start Guide
10	Safety
11	Location of Installation and Airflow Clearance
12	Installation & Connection
16	Controller Operation
22	WiFi Settings
28	Troubleshooting
33	Maintenance & Information
38	Technical Support and Warranty Requests
39	Warranty



Introduction

Congratulations on your recent purchase of your Oasis Heat Pump.

Please take a moment to read through the entire manual before installing your new unit.



This manual contains all the necessary information in regard to the installation, troubleshooting, operation and maintenance of this unit.

Ensure instructions in this manual are adhered to at all times. Failing to comply with these recommendations will invalidate the warranty. While every effort has been made to ensure that the information contained in this manual is accurate and complete, no liability can be accepted for any errors or omissions.

The Oasis heat pump is the ideal choice for recreational pool & spa owners looking to extend their swim season with minimal running costs. Designed with the latest technology including stepless full DC inverter compressors, fans, and control systems – the Oasis iX series is the energy efficient and environmentally friendly way to enjoy a longer swim season.

There are **4** different size models in our NZ range:

Single Phase	Three Phase
RP22	RP40T
RP26	
RP32	

It is important that you read through the manual to identify the key areas you need to understand, particularly the following:

- Health and Safety Concerns
- Installation requirements
- How to operate the major features of the unit
- The importance of maintenance
- If you have a problem, what you can do to trouble shoot before you contact your pool professional
- Your entitlements under the product warranty.

Thank you again for choosing an Oasis Heat Pump.

Please note: Oasis reserves the right to change the specification of the hardware and software described herein at any time without prior notice. This manual has been designed to cater for installation rules and codes in NZ. Specific rules and regulations for other countries may differ. Please speak with your installer should you have any questions.

Important Things to Note

Check that you have received the package in good condition

Ensure you meet the minimum clearances and recommended installation locations as outlined in the manual. Make sure that the unit is installed as per the ventilation diagrams to ensure efficient heating

All accessories (drain barbs, rubber feet and barrel unions) and the installation manual is contained in a plastic bag inside the packaging of your heat pump

Please refer to the warranty section of this manual and follow the outlined registration process

To avoid voiding your warranty, please refer to the maintenance requirements outlined in the warranty section of the manual

The time it takes to INITIALLY heat up your pool will be influenced by factors such as the pool's size, environmental conditions, and the installed system's capacity

The Heat Pump unit discharges condensation water from the bottom, similar to a household air conditioner, and requires regular inspection of the condensate drain to detect any obstructions or debris accumulation. It is important to keep the drain clean to allow for smooth condensate flow and proper discharge to the drainage system

If a Wi-Fi enabled controller has been installed, make sure that the heat pump area has sufficient 2.4ghz Wi-Fi signal strength

Under no circumstances should an unlicensed person attempt to install or repair an Oasis heat pump themselves

Use genuine Oasis spare parts only. Failure to comply with these recommendations will invalidate the product warranty

For any technical questions or additional information please contact your local distributor or contact Oasis directly

Directive 2002/96/EC (WEEE)

The crossed-out waste bin symbol under the appliance indicates that it should not be thrown away with regular household domestic waste at the end of its useful life. Instead, it should be taken to an electronic recycling centre or returned to the dealer when you buy a new one

Directive 2002/95/EC (RoHs):

This product is compliant with directive 2002/95/EC (RoHs) concerning restrictions for the use of harmful substances in electric and electronic devices.

Specifications

The data presented relates exclusively to the Oasis heat pump and excludes any auxiliary equipment. The product specifications mentioned above were precise at the time of printing, but are subject to change without prior notice.

For the latest and most accurate information, please contact an Oasis heat pump specialist.

			RP14	RP16	RP18	RP22	RP26	RP32	RP32T	RP40T	
Performance Data	Air 26°C Water 26°C	Heating capacity in Turbo mode	kW	13.5	16.0	18.0	21.5	26.0	31.5	31.5	40.0
		Heating capacity in Smart mode	kW	11.5	13.5	15.0	17.6	22.0	27.0	27.0	35.0
		COP		19.6~7.5	20.1~7.1	19.2~7.1	20.5~7.2	20.3~7.2	19.6~7.4	19.6~7.4	19.2~7.2
		COP at 50% capacity		14.9	14.8	14.6	15.0	15.0	14.8	14.8	14.7
		COP at 20% capacity		19.6	20.1	19.2	20.5	20.3	19.6	19.6	19.2
		Air 15°C Water 26°C	Heating capacity in Turbo mode	kW	9.0	10.5	12.0	14.5	18.0	22.0	22.0
	Heating capacity in Smart mode		kW	7.3	8.8	10.0	12.0	14.8	18.0	18.0	24.0
	COP			7.9~5.2	8.8~5.2	8.0~5.0	8.8~5.2	9.3~5.3	8.1~5.3	8.1~5.3	8.0~4.9
	COP at 50% capacity			7.2	7.5	7.2	7.4	7.8	7.4	7.4	7.4
	COP at 20% capacity			7.9	8.8	8.0	8.8	9.3	8.1	8.1	8.0
	Air 35°C Water 28°C	Cooling capacity	kW	6.3	9.0	10.0	11.3	13.0	15.0	15.0	19.5
		Sound Pressure at 1m	dB(A)	37.8~45.9	41.0~46.7	41.5~47.3	41.9~49.5	39.7~49.8	42.1~50.3	42.1~50.3	41.5~50.5
		Sound pressure of 50% capacity at 1m	dB(A)	40.3	42.7	42.5	43.3	43.1	45.2	45.2	42.5
Sound pressure at 10m		dB(A)	17.8~25.9	21.0~26.7	21.5~27.3	21.9~29.5	19.7~29.8	22.1~30.3	22.1~30.3	21.5~30.5	
Rated input power at air 15°C		kW	0.19~1.7	0.20~2.08	0.25~2.45	0.27~2.74	0.32~3.31	0.46~4.1	0.46~4.1	0.60~5.7	
Rated input current at air 15°C		A	0.83~7.39	0.87~9.04	1.09~10.65	1.17~11.9	1.39~14.4	2.01~17.8	0.66~5.91	0.87~8.22	
Advised water flux		m ³ /h	3~4	4~6	4~6	6.5~8.5	8~10	10~12	10~12	12~18	
Technical Specifications	Operating air temperature	°C	-20 ~ 43								
	Refrigerant		R32 GWP (global warming potential) – 675								
	IPX rating		IPX4								
	Power Supply	V/Ph/Hz	240/1/50						400/3/50		
	Net Dimensions (L x W x H)	mm	945x432x 660	1045x432x 660	1045x432x 660	1195x432 x760	1072x536 x956	1264x536 x956	1264x536 x956	1364x536 x956	
	Net Weight	kg	65	72	73	82	100	122	132	147	

Specifications

Unit Dimensions Unit: mm

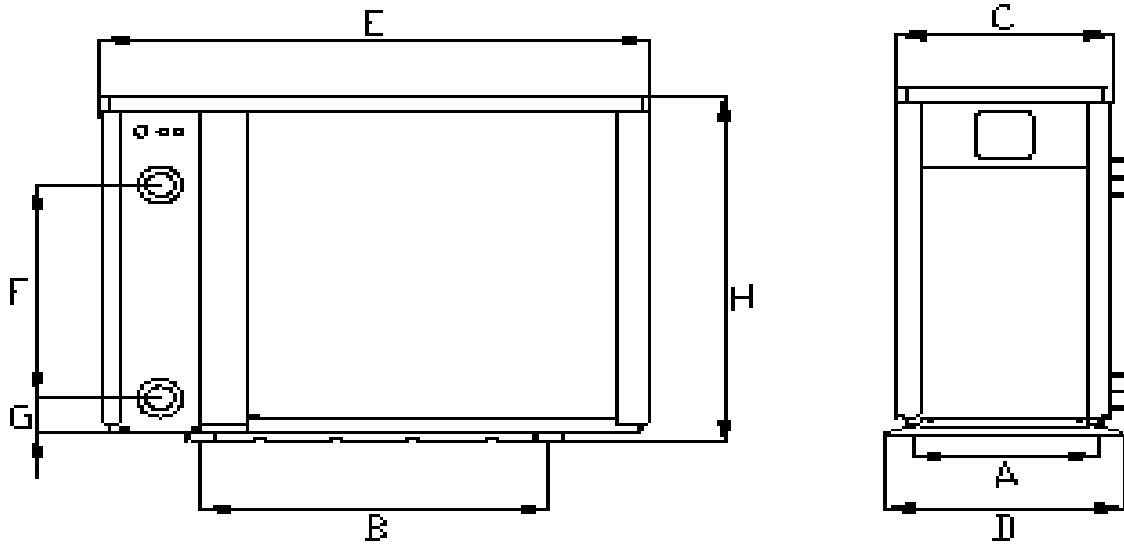



	A	B	C	D	E	F	G	H
RP22	402	824	389	432	1195	470	73	760
RP26	511	700	498	536	1072	550	73	956
RP32	511	891	498	536	1264	570	73	956
RP40T	511	991	498	536	1364	670	73	956

Modes / Codes





Modes

The heat pump has three modes: Turbo, Smart and Silence. They have different advantages under different conditions.

MODE	ADVANTAGES
Turbo mode 	Heating capacity: 120%~20% Fast heating, intelligent optimization according to ambient temperature and water temperature Energy efficiently saving
Smart mode 	Heating capacity: 100%~20% Intelligent optimization according to ambient temperature and water temperature Energy efficiently saving
Silence mode 	Heating capacity: 60%~20% Use at night

Codes

Please note that the following codes are not failure

CODE	DESCRIPTION
	No water protection
	Anti-Freezing Protection
	Out of the operating range
	Insufficient water flow protection
	Power abnormal

Quick Start Guide



- Ensure you meet the minimum clearances and recommended installation locations as outlined in the manual.
- All accessories (drain barbs, rubber feet and barrel unions) and the installation manual is contained in a plastic bag inside the packaging of your heat pump

Pre-Installation

1. Install the supplied rubber anti-vibration feet under the unit.
2. Position the heater on a level pad in the desired location on the pool water return line (as shown in the example image below).
3. Install the supplied condensation barb(s) to the underside of the unit and direct the condensation to an appropriate drainage point. The unit must sit level to allow condensation to drain correctly.

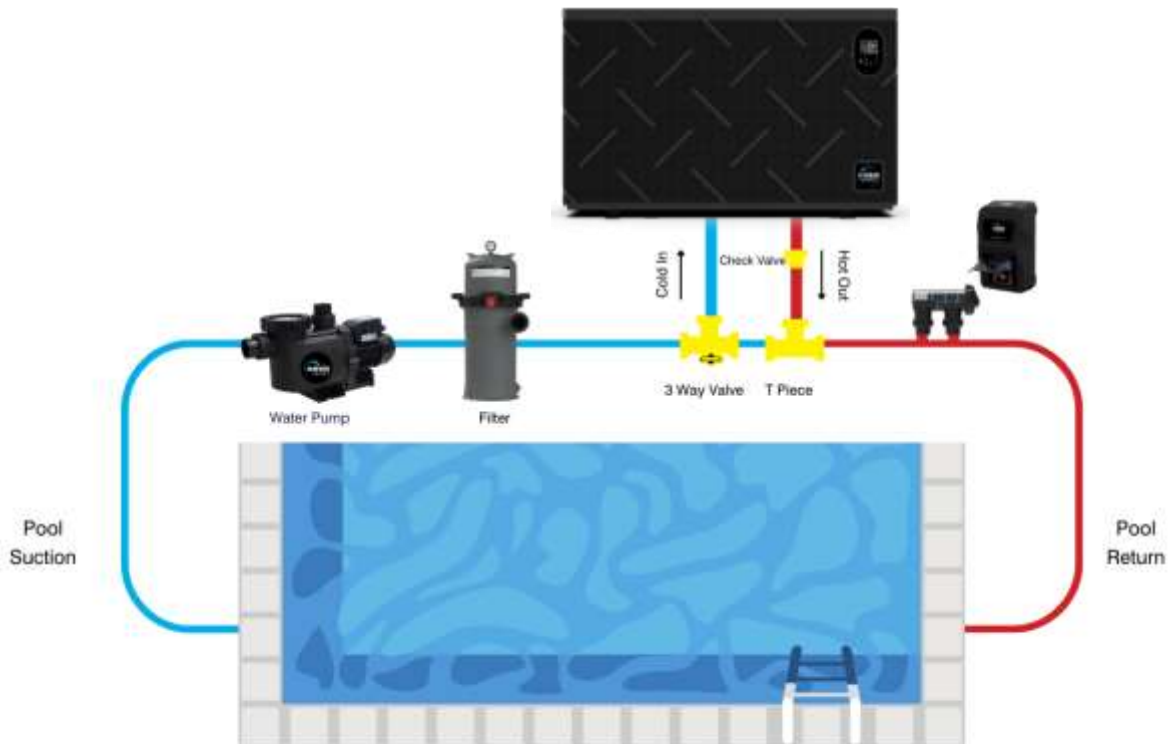

The schematic diagram is for reference only. Please check the water inlet/outlet label on the heat pump while plumbing the unit.

Plumbing Installation

PLEASE NOTE: The supplied fittings accept standard 40mm PVC pressure pipe.

1. Attach the supplied barrel unions to the inlet and outlet (hand tighten). Use plumbing tape on the thread and ensure the O-rings are installed and lubricated with a silicone-based grease.
2. Install a 3-way valve at the cold-water inlet and create a bypass by connecting a “T” piece to the heated line. This will allow for the adjustment of water flow to the unit.
3. Make the plumbing connections and brace pipework where necessary to prevent lateral strain being applied to the unions. This will aid in preventing future leaks.

Quick Start Guide

Electrical Connection



OASIS HEAT PUMPS MUST BE CONNECTED BY A LICENSED ELECTRICIAN IN ACCORDANCE WITH ALL RELEVANT AUSTRALASIAN STANDARDS, APPLICABLE LAWS AND LOCAL LEGISLATIONS.

Under no circumstances should an unlicensed person attempt to install or repair an Oasis heat pump themselves.

It is essential to ground the unit to safeguard against any short circuits that may occur inside the unit. Additionally, bonding is necessary.

The unit has a separate moulded-in junction box with a standard electrical conduit nipple already in place.

1. Remove the external cover to the electrical terminal by removing the screws and the terminal cover panel.
2. Feed the electrical cable lines through the conduit nipple and attach the electric supply wires.
3. To complete the electrical connection, install electrical conduit, UF cable or other suitable means as specified (as permitted by local electrical authorities) and connect the cable to a dedicated power supply branch circuit equipped with appropriate circuit protection.

Disconnect

An isolating switch **MUST** be installed within close proximity and in plain sight of the unit.

Initial Startup & Commissioning

NOTE: The water pump must be running and water circulating through the heat pump for the system to operate.

1. Turn on your water pump and check for water leaks and verify water flow to and from the pool.
2. Turn on the electrical power supply to the Oasis unit.
3. Press the ON/OFF **○** key of the controller for half a second, the heat pump will start within 60 seconds.
4. Adjust the bypass valve to set the water flow rate in accordance with the specifications on Page 5 of this manual. After 10 minutes of operation, the optimal flow rate will result in an inlet/outlet temperature difference of between one and two degrees Celsius.
5. Once the unit is running, switch off the water pump. The unit should then shut down on its own, which indicates the flow switch is functioning correctly.
6. Run both the unit and water pump continuously (night and day), until the desired water temperature is reached.
7. When the water-in temperature reaches this level, the unit will decrease its speed for a specific time. If the temperature remains constant for 45 minutes, the unit will shut down for one hour and sample the water temperature each hour thereafter, proving there is water flow.

In the event that the pool temperature drops more than 0.5 degrees below the desired temperature, the unit will restart automatically.

In case of power failure during the operation of the machine, the machine will automatically restart when the power is restored



Installation, repair, or relocations should be completed by a fully qualified technician. If not carried out correctly, several hazards, such as fire, electric shock, water leakage, and injury, may occur.

This appliance is not intended for use by persons (including children) with reduced physical sensory or mental capabilities, or lack of experience and knowledge, unless they have been given supervision or instruction concerning use of the appliance by a person responsible for their safety.

- A circuit protection device must be installed for the unit.
- To avoid risk of electrical shock, the unit must have a good power connection and earthing.
- Before obtaining access to terminals all supply circuits must be disconnected.
- The unit is equipped with an over- load protection system. After a stoppage, the unit will not start for at least 3 minutes.
- Do not use any means to accelerate the defrosting process or to clean other than those recommended by the manufacturer.
- If installing in an enclosed area, the equipment should be kept away from any sources of ignition. This includes items such as open flames, operating gas appliances, or operating electric heaters. Any refrigerant leakage can potentially result in a fire hazard.
- Do not pierce or burn the unit.
- Be aware that refrigerants may not contain an odour.
- If the supply cord is damaged, it must be replaced by the manufacturer, a qualified service agent or similarly qualified persons in order to avoid a risk.
- This appliance must be installed in accordance with national wiring regulations.
- Avoid lifting the water unions when relocating the heat pump, as doing so may cause damage to the titanium heat exchanger inside the unit.
- Avoid placing obstructions in front of the air inlet and outlet of the heat pump

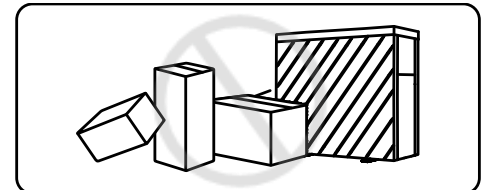
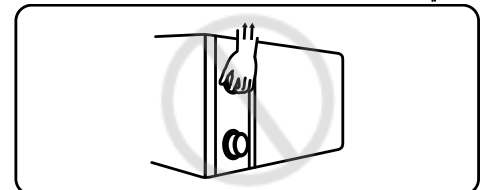
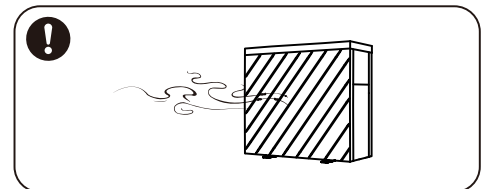
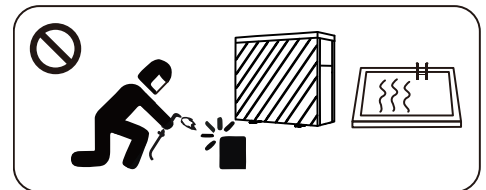
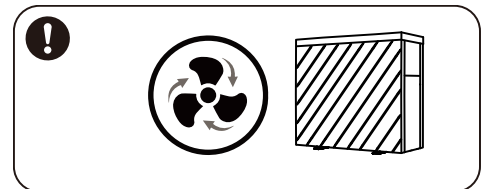
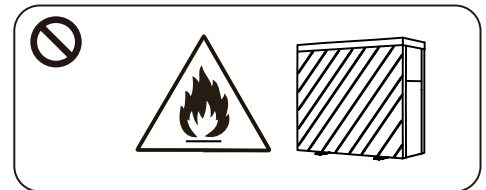

Location of Installation and Airflow Clearance

Before installation it is very important to ensure these five variables are carefully checked to allow the unit to operate correctly.

1. Heater condition
2. Clearances & air flow
3. Location
4. Adequate water flow & plumbing
5. Correct electrical connection & supply

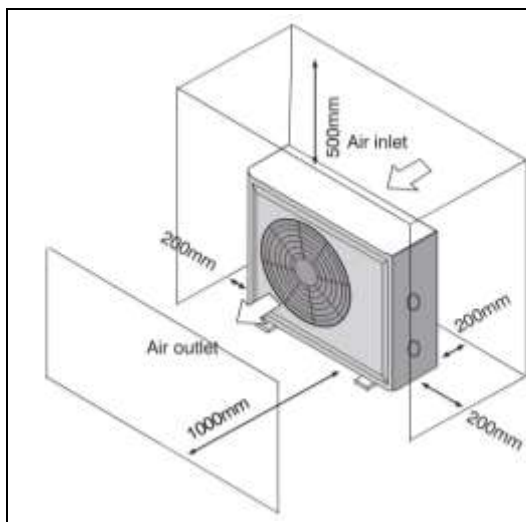

To ensure optimal performance and prevent potential damage, the heat pump unit requires continuous fresh air while running.

The heater, which draws up to 80m³/min of ambient air through the sides and discharges it through the top fan cowl, must not be installed indoors or in an enclosed space without adequate ventilation. Doing so can result in poor performance, and in extreme cases, damage to the heater.

Locating the heater in an enclosed area will cause discharged cold air to recirculate into the unit, lowering heating efficiency and potentially causing icing up.

- Heat Pumps should ONLY be installed in an outdoor location with appropriate ventilation.
- Ensure the heater is installed in a well-ventilated area with plenty of fresh air.
- Leave sufficient space for unobstructed airflow into and out of the heater.
- At least 3.5m away from the water's edge.
- No greater than 7.5m from the water's edge (to avoid heat loss from the piping).
- No greater than 5.0m below the water level of the pool/spa.
- Ensure the heat pump is not installed close to harsh or corrosive chemicals.
- The heat pump MUST be installed on a flat level surface (the feet supplied are adjustable).
- A minimum gap between walls/fences etc of 200mm on the back and sides and 500mm overhead and 1000mm on the front clearance.

Make sure the heat pump is not located where large amounts of water may run-off from a roof into the unit. Sharp sloping roofs without gutters will allow excessive amounts of rain water mixed with debris from the roof to be forced through the unit. A water deflector may be needed to protect the heat pump.

Airflow

An air intake at the back of the unit draws warm ambient air, while a discharge fan at the front releases cold air. In cases where an obstruction is within **1.0m** of the front discharge of the installed unit, such as a wall or fence, installation of a deflector redirects air flow upwards or sideways instead of directly towards the obstruction.

Please contact our Support Specialist to discuss appropriate installation locations.

Installation & Connection

Heater Condition

Upon receiving the heater, inspect its packaging thoroughly for any apparent signs of damage and IMMEDIATELY notify your supplier if there are any signs of rough handling.

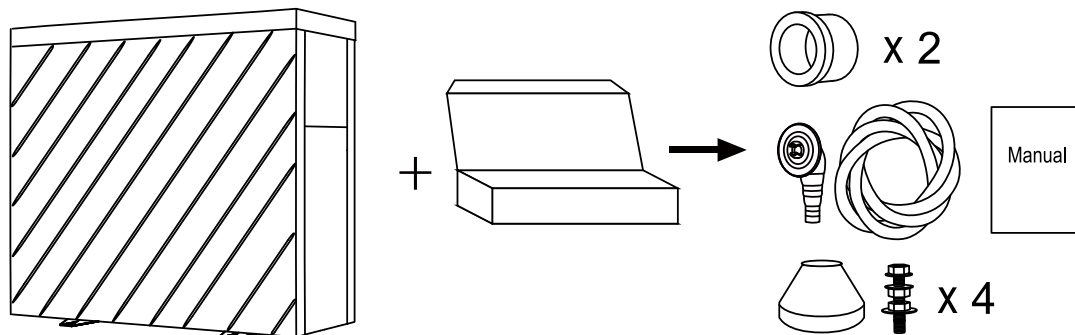

Plumbing

The unit's exclusive titanium heat exchanger requires no special plumbing arrangements except a bypass.

Flow Rate

Ensure the water pump and plumbing is capable of meeting or exceeding the required flow rate in accordance with the specifications on Page 5 of this manual.

Location

Connect the unit in the pool pump discharge (return) line downstream of all filter and pool pumps, and upstream of any chlorinators, ozonators or chemical pumps.

Oasis heat pump models have quick coupler fittings which accept 40mm PVC pressure pipe for connection to the pool or spa filtration piping.

Ensure pipework connecting to the inlet/outlet unions is appropriately supported as any lateral strain may cause the rubber O-rings to pinch and leak.

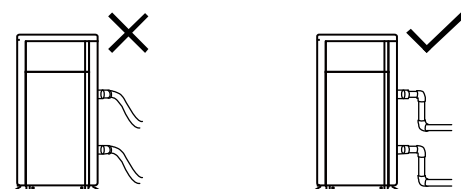

Lubricate all O-rings with silicon grease prior to fitment and apply plumbing tape to the threads for additional security.

Water unions step by step

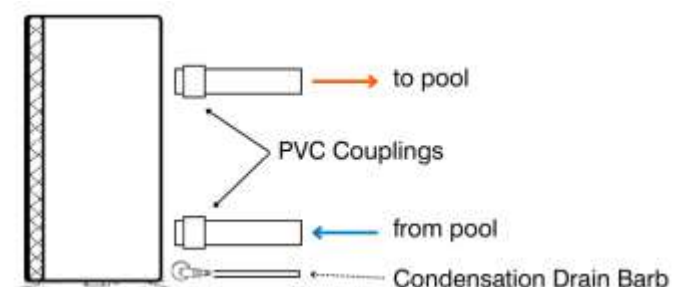

Installation & Connection

First Time Operation

When starting for the first time:

- Ensure the water pump is adequately primed.
- Adjust bypass valve to provide full flow to heat pump, which will aid in purging air from the system.
- Switch on the water pump and thoroughly check all plumbing connections for leaks.
- Start the heat pump in accordance with the instructions on Page 8 of this manual.

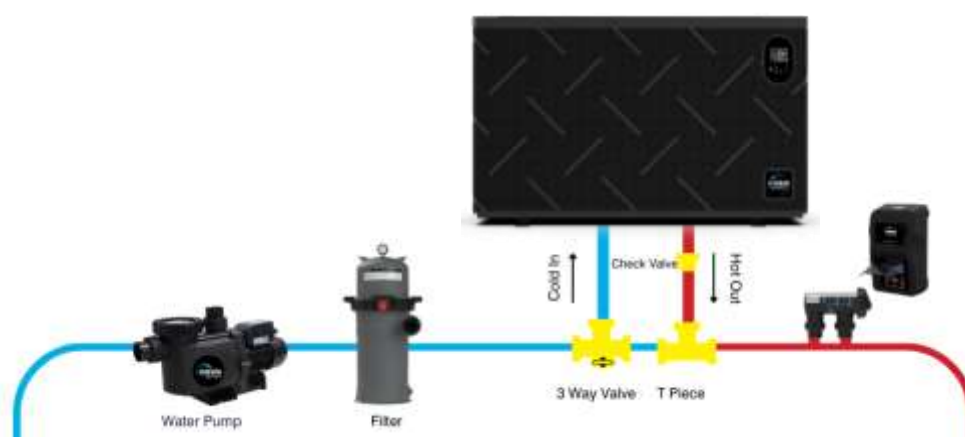

The diagram provided is intended for informational purposes only.
It depicts all the essential parts required, which must be obtained by the installer or the user.

Adequate Water Flow

All heat pumps have a factory pre-set internal water flow switch. If there is insufficient water flow the unit will not operate.

It is **CRITICAL** that there is sufficient water flow to the unit. Incorrect water flow can cause a loss of efficiency and possible damage to the unit. Optimal water flow rates are listed on Page 5 of this manual. It is imperative that water flow is kept as close as possible to these flow rates. Correct water flow not only offers optimal heater performance but may also prevent possible damage to your heater. As a rule of thumb there should be a minimum inlet/outlet temperature differential of one degree Celsius and a maximum of two degrees Celsius.

Before connecting the heater to the plumbing, all piping must be thoroughly flushed to ensure no debris can enter the heater. Failure to remove pipe debris can jam or damage the flow switch and may cause damage to the heater. When cleaning the pool, it is advisable to turn off your heater as restricted water flow may cause the heater to shut down and indicate low water flow fault (E03 error) and/or a high refrigerant pressure fault (E01 Error).



A variable speed pump or bypass valve and plumbing **MUST** be fitted to allow water flow to be adjusted through the heater. Do not directly connect a water pump with higher flow than required to the heat pump.

Installation & Connection

Time Delay

The unit is equipped with a 3-minute restart delay included to protect control circuit components and to eliminate short cycling.

This time delay will automatically restart the unit approximately 3 minutes after each control circuit interruption.

Initial Heat Up Time

Initial heat up times will vary depending on the size of your pool, environmental conditions and the capacity of the system installed. After installation, please allow the unit and pool pump to run continuously until the desired pool water temperature is reached (it may take several days for the pool to initially reach the set temperature).

Once the pool water reaches the desired set temperature, the unit will shut off. The unit will automatically restart (provided your pool pump is running) when the pool temperature falls more than 0.5°C below the desired set temperature.

Rubber Feet

All units are provided with rubber feet which we highly recommend being installed. The rubber feet help reduce vibration of the unit and provide a space below the heat pump to install the drainage barbs.

Condensate Drain Barbs

Fit the condensate drain barbs into the 2 holes under the unit if you need to direct water away from the heater. If the barb is too stiff, place it in hot water to soften.

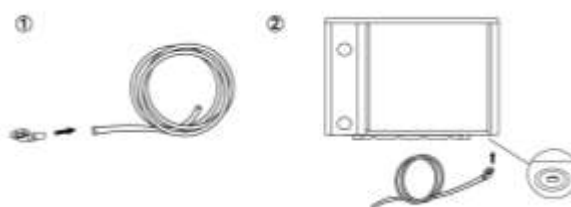

Drainage & Condensation

Whilst the heater is operating, water in the air condenses on the fins of the evaporator. In the instance of high humidity, the condensate may be several litres per hour.

This may give the impression that the heater is leaking, however this is a normal function of heat pumps.

The heater will automatically activate reverse cycle or de-icing mode when required which also increases condensate discharge. This normally occurs at temperatures below 8 deg C. As the ice melts from the evaporator fins, water will be discharged through the base of the heater. As an option a pipe can be connected to the drain on the base of the unit to direct condensate water to an appropriate location.



A quick way to verify that the water is condensation is to shut off the unit and keep the pool pump running. If the water stops running out of the base pan after several minutes, it is condensation.

Another method is to test the drain water for chlorine using a test strip. If there is no chlorine present, it can be concluded that the discharge is condensation.

Installation & Connection

Electrical Connection

Ensure the power cable and circuit protection device are of a suitable size for the heater being installed. Also check that there is adequate voltage and current available at the heater connection to run the unit.

Voltage range should be 220-240 volts for single phase, and 380-415 volts for 3 phase units. Voltage ranges outside these parameters will cause heater damage and void your warranty.

1. Ensure power is disconnected during installation or service.
2. Always comply with the national and local electrical codes and standards.
3. Ensure the electrical cable size is adequate for heater requirements at the installation location.
4. The heater must be equipped with appropriate circuit protection and isolation devices.
5. An additional circuit protection device must be installed between the heater and the water circulation pump if a water pump is hard-wired into the heater. Please note recommended circuit breaker sizes make no allowance for a water pump hard wired into the heater.
6. The unit must be well earthed. Remove the front panel to access the electrical connection terminals of the heater. The electrical wiring diagram is affixed to the inside of the front panel or at the back of this manual.



Heater electrical installation undertaken by an unlicensed installer will void the warranty. Correct installation is required to ensure safe and efficient operation of your pool heater.

A licensed electrician must read the installation manual before connecting.

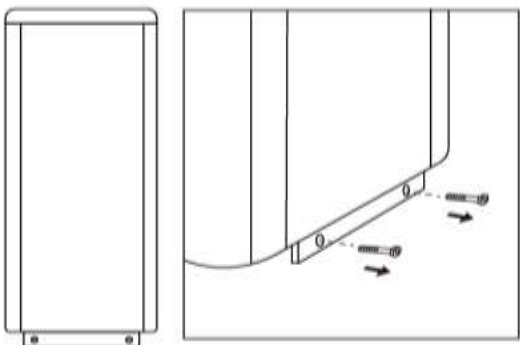
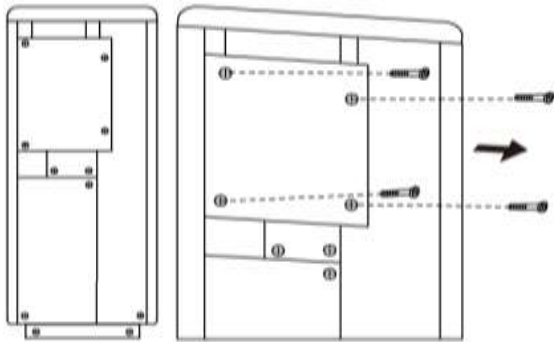
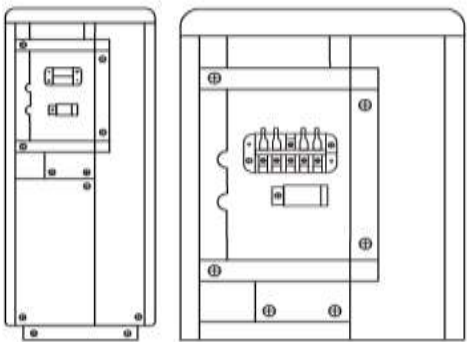



	
	<p>Use a cross screwdriver to remove the two screws located at the bottom of the right-side panel.</p> <p>Detach the lower half of the panel.</p> <p>Proceed to unscrew the four screws on the cover of the electrical box.</p> <p>Connect the terminals following the electrical diagrams.</p>

Controller Operation

Main Controller Interface

The heat pump is equipped with a digital control panel with a touch screen, electronically connected and pre-set at the factory in heating mode.











SYMBOL	DESIGNATION	FUNCTION
	ON/OFF	Power On/Off Wi-Fi setting
	Unlock	Press it for 3 seconds to unlock/lock screen After screen is unlocked, press it to select mode. Auto 12~40°C / 54°F~104°F Heating 18~40°C / 64°F~104°F Cooling 12~30°C / 54°F~86°F
	Speed	Select Turbo/Smart/Silence mode
	Up / Down	Adjust set temperature
	Timer	Timer and Time Setting

NOTE



will be light all the time when power is on



SYMBOL	DESIGNATION	
	Auto	
	Heating	
	Cooling	
	80%	Heating capacity percentage
	0.68kW	Real-time power consumption display
	Wi-Fi connection	
	Turbo/Smart/Silence mode	1
	Water inlet	2
	Water outlet	3

Controller Operation

Standby screen

When the screen is locked, the key lamp will be off.

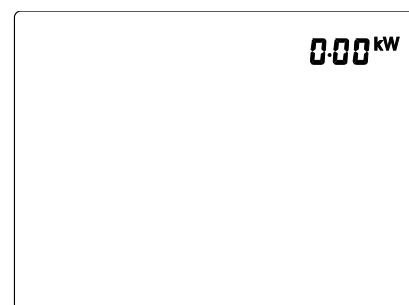

Screen lock / unlock



If no operation in 30 seconds, screen will be locked.

When HP is off, screen will be dark and "0%" or "0.00kW" will be displayed.



Only after screen is unlocked, any other buttons can be functioned.

Press  for 3 seconds to lock screen and it will be dark / unlock screen and it will be lit up.



Power On

Press  for 3 seconds to light up screen, then press  to power on heat pump





Adjust Set Temperature

When screen is unlocked, press  or  to display or adjust the set temperature.







Switching of real-time power consumption and heating capacity percentage display

Press  and  5 seconds to switch between real-time power consumption display and heating capacity percentage display. Real-time power consumption function available for single-phase only.

Mode Selection

Press  to select mode
 Auto  : adjustable temperature range 12~40°C / 54°F~104°F
 Heating  : adjustable temperature range 18~40°C / 64°F~104°F
 Cooling  : adjustable temperature range 12~30°C / 54°F~86°F





Turbo/Smart/Silence mode selection

Press  to enter Turbo mode, and screen shows , then press  to enter Silence mode, the screen shows .
 Press  again, the screen shows  and return to Smart mode.

Auto Defrosting



When heat pump is defrosting,  will be flashing. After defrosting,  will stop flashing.

Compulsory Defrosting

When heat pump is heating, press  and  together for 5 seconds to start compulsory defrosting, and  will be flashing. After defrosting,  will stop flashing.





Note: Compulsory defrosting intervals should be more than 30 minutes and the compressor should run for more than 10 minutes at heating mode.

Temperature display

Conversion between °C and °F, Press "  " and "  " together for 5 seconds to switch between °C and °F.

Controller Operation

Timer The timer function is a 24-hour system, please calibrate with local time.

Real time setting Press  for 5 seconds to enter real time setting, press **+** or **-** to adjust the hour. After completion, press  switch to minute setting. And then press  to confirm. During real time setting, you can press  once to cancel the setting

Time display When the machine is off, the time display on the top right corner is real time. When the machine is on, the real time can be shown 10 seconds if you press timer once.

Timer setting Press  for 10 seconds and release when you hear the “beep” sound to enter the timer setting.

Timer on setting,  will be flashing

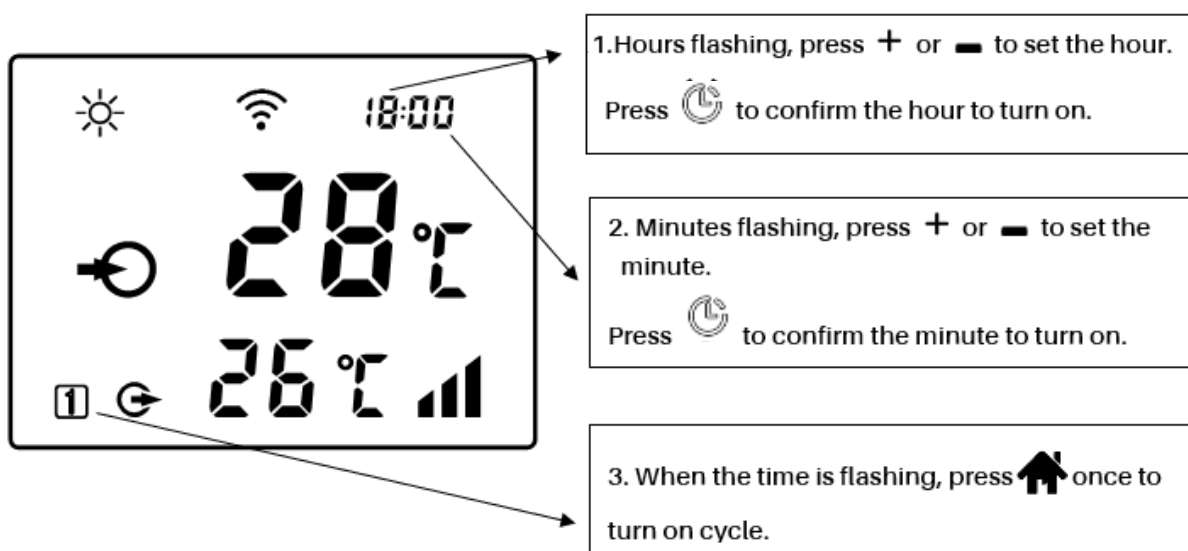

1. Hours flashing, press **+** or **-** to set the hour.
Press  to confirm the hour to turn on.

2. Minutes flashing, press **+** or **-** to set the minute.
Press  to confirm the minute to turn on.

3. When the time is flashing, press  once to turn on cycle.

Finally, press  once to confirm timer on setting

The icon in the lower left corner indicates as below:

 Timer on every day

 Timer on one time

No symbol No timer setting

Controller Operation

Timer off setting, **0** will be flashing

The diagram shows a controller display with the following elements: a sun icon, a Wi-Fi signal icon, the time 20:30, a central temperature display of 28°C, a lower temperature display of 26°C, a signal strength icon, and a flashing '0' icon in the bottom left corner. Three numbered boxes provide instructions:

1. Hours flashing, press **+** or **-** to set the hour. Press to confirm the hour to turn off.
2. Minutes flashing, press **+** or **-** to set the minute. Press to confirm the minute to turn off.
3. When the time is flashing, press once to turn on cycle.

Finally, press once to confirm timer off setting.

The icon in the lower left corner indicates as below

	Timer off every day
	Timer off one time
No symbol	No timer setting

After setting, the icon in the lower left corner indicates as below

	Timer on every day	Timer off every day		Timer on every day	No timer off
	Timer on every day	Timer off one time		Timer on one time	Timer off every day
	No timer on	Timer off every day		Timer on one time	Timer off one time
	Timer on one time	No timer off		No timer on	Timer off one time
No symbol	No timer on	No timer off			

Controller Operation



Parameter Details

Parameter Checking

Press and together for 5 seconds to enter “Parameter Checking” status, the parameter code “P0” and the parameter value “0” will display on the screen, such as “P0 0”, which means water pump running way is continuous.

In “Parameter Checking” status, press or to check the parameters.

Parameter Modification

In “Parameter Checking” status, press to enter the “Parameter Modification” mode, press or to change the values, then press to confirm and quit “Parameter Modification” mode, press to quit “Parameter Checking” status.



No	Content	Adjust Range	Step Length
P0	Water Pump Running Way	0: Continuous 1: Water temp control 2: Time/water temp control	1
P1	Time Setting (Only available when the water pump running way is set to “2”)	10 ~ 120 min	5 min
P2	Compressor Continuously Running Time between Defrosting Mode	30 ~ 90 min	1 min
P3	Defrosting Entry Temp	-17~0°C / 1~32°F	1°C /1°F
P4	Maximum Defrosting Running Time	1 ~ 12 min	1 min
P5	Defrosting Exit Temp	8~30°C /46~86°F	1°C /1°F

Controller Operation

Status Checking

Running status checking

Press  for 5 seconds, enter into “Running status checking”, and the screen alternately shows status point “C0” and its corresponding value.

Check all status points and their corresponding value through  or , Press  to quit “running status checking” mode

Symbol	Content	Unit
C0	Inlet water temp.	°C / °F
C1	Outlet water temp.	°C / °F
C2	Ambient temp.	°C / °F
C3	Exhaust temp.	°C / °F
C4	Outer coil pipe temp. (Evaporator)	°C / °F
C5	Gas return temp.	°C / °F
C6	Inner coil pipe temp. (Titanium heat exchanger)	°C / °F
C9	Cooling plate temp.	°C / °F
C10	Electronic expansion valve opening	P
C11	DC fan speed	(r/min)

WiFi Settings

Introduction

The Oasis RP Wi-Fi app is presented as a premium feature for your convenience.

This smartphone controller app, compatible with both iOS and Android devices, offers a user-friendly and convenient solution for monitoring and controlling your pool temperature. With this app, you can easily adjust settings, set timers, receive error alerts, and even provide remote access to technicians for troubleshooting purposes.

App Installation

To download, simply visit your device's app store and search for 'Inverter Life'.



App Set Up

Create an Account

In order to take advantage of the app, you must first register an account.

Open the app and the User Agreement and Privacy Policy may pop up. Click "Agree" to proceed

1. Tap on the 'Registration' button
2. Enter your email address and Click "Get Verification Code", ensuring you tick the "I Agree" to proceed
3. Enter the Verification code that was sent
4. Set a password as per the conditions and click "Completed"



5. Your account setup is complete, and the main screen is now ready for the addition of a device.

WiFi Settings

Add Your Device & Configure Wi-Fi

There are 3 methods for connection. Auto Discovery (Bluetooth), EZ Mode (Easy-connect) and AP Mode.

BEFORE PROCEEDING, MAKE SURE YOUR DEVICE IS CONNECTED TO THE WI-FI NETWORK, YOUR ROUTER IS CONFIGURED AT 2.4 GHZ, AND THE BLUETOOTH FUNCTION IS ENABLED

Auto Discovery (Bluetooth)

Press  for 3 seconds after the screen unlock,  will be flashing rapidly to enter Wi-Fi connection status.

Click "Add Device", wait for the app to search for the device and then click "add", then follow the instructions below to finish the device connection.

Note: It will take some time to scan, please be patient. Only Wi-Fi modules with Bluetooth functions can use this method.

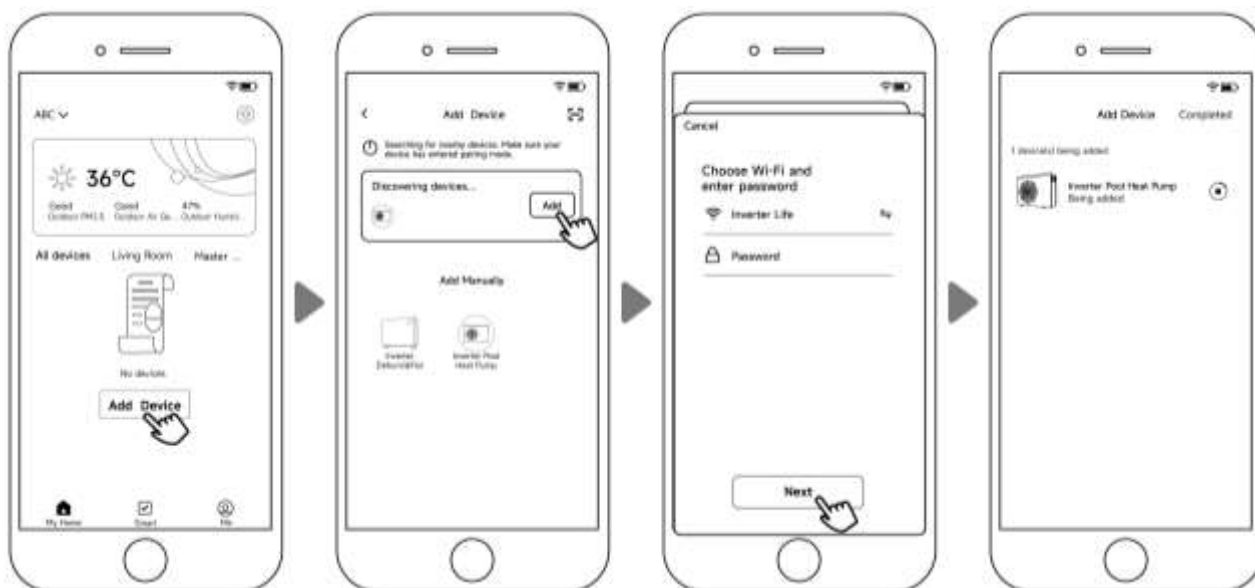

WiFi Settings

EZ Mode (Easy-connect)

Press  for 3 seconds after the screen unlocks,  will be flashing rapidly to enter Wi-Fi connection status.

Click "Add device", and follow the instructions below to finish connection.  display on the screen once the Wi-Fi connection success.

Note: After allowing the APP to locate, it can read the Wi-Fi name automatically.

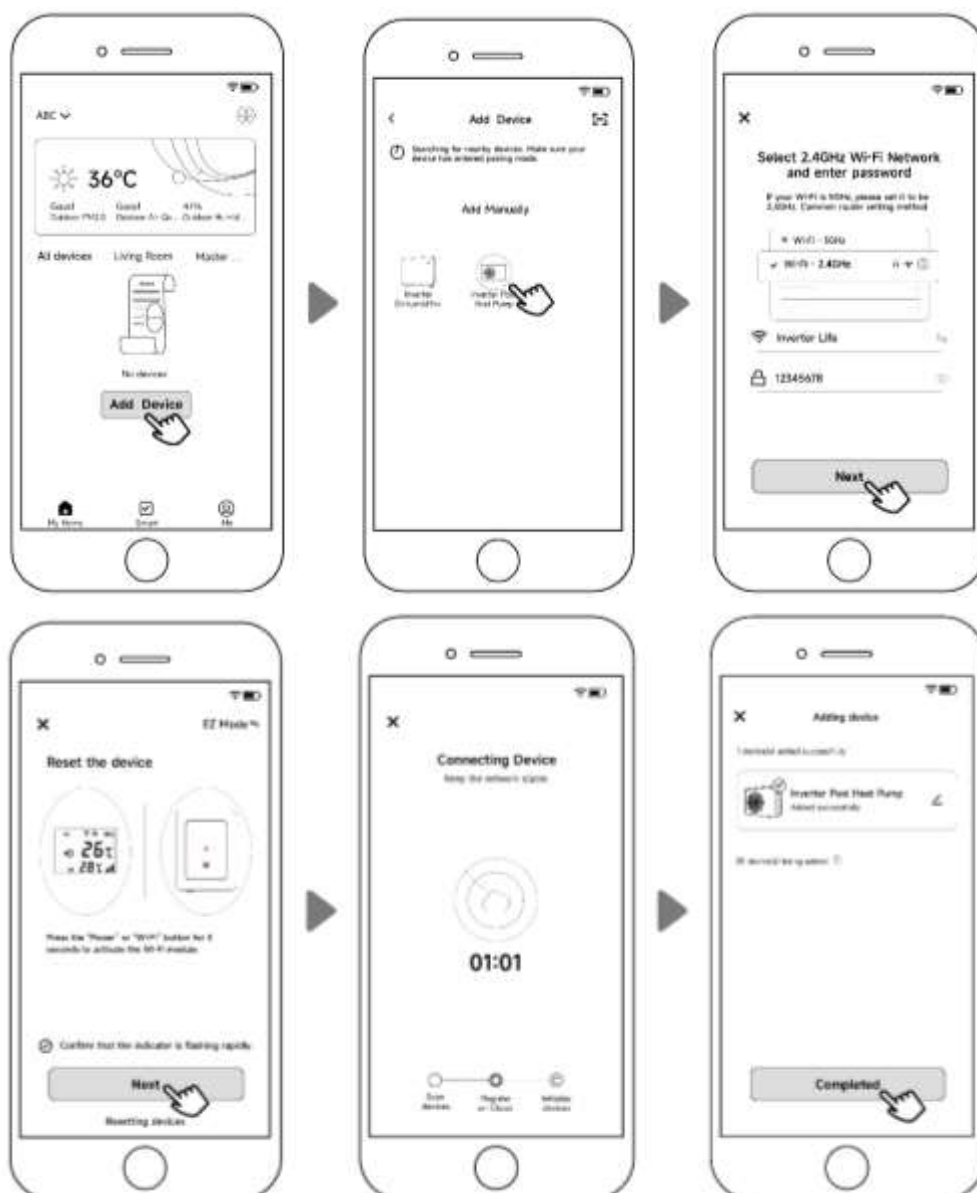

WiFi Settings

AP Mode

Press  for 10 seconds after the screen unlock,  will be flashing slowly to enter Wi-Fi connection status.



Click "Add device", and follow the instructions below to finish connection.  display on the screen once the Wi-Fi connection success.

Note: If it doesn't jump automatically, click "Confirm hotspot connection, next".



NOTE: If connect fails, please make sure your network name and password are correct. And your router, mobile phone and device are as close as possible.

Wi-Fi reconnection (When Wi-Fi password changes or network configuration changes)

Press  for 10 seconds,  will be flashing slowly for 60 seconds. Then  will be off. The original connection will be removed. Follow steps above for reconnection.

WiFi Settings

Operation Menu

The following instructions are for heat pumps with heating and cooling functions.

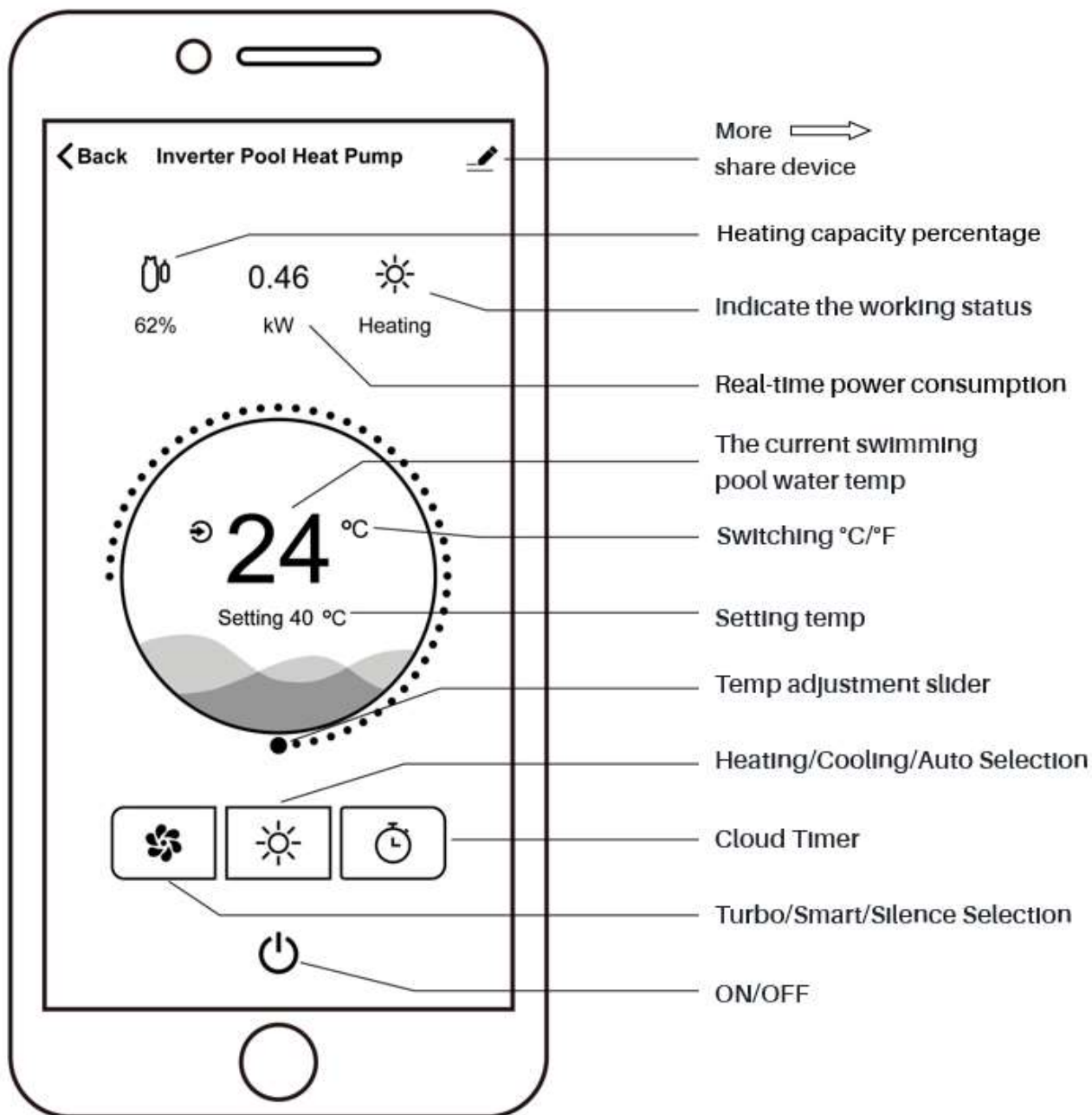

WiFi Settings

Share devices with your family members

Create family

Please set a name for the family and choose the room of the device



Sharing Operation

After connection, if your family members also want to control the device.

Once your family members also register on the app initially subsequent operations can be conducted by the administrator as follows. (The following pictures are for reference only):

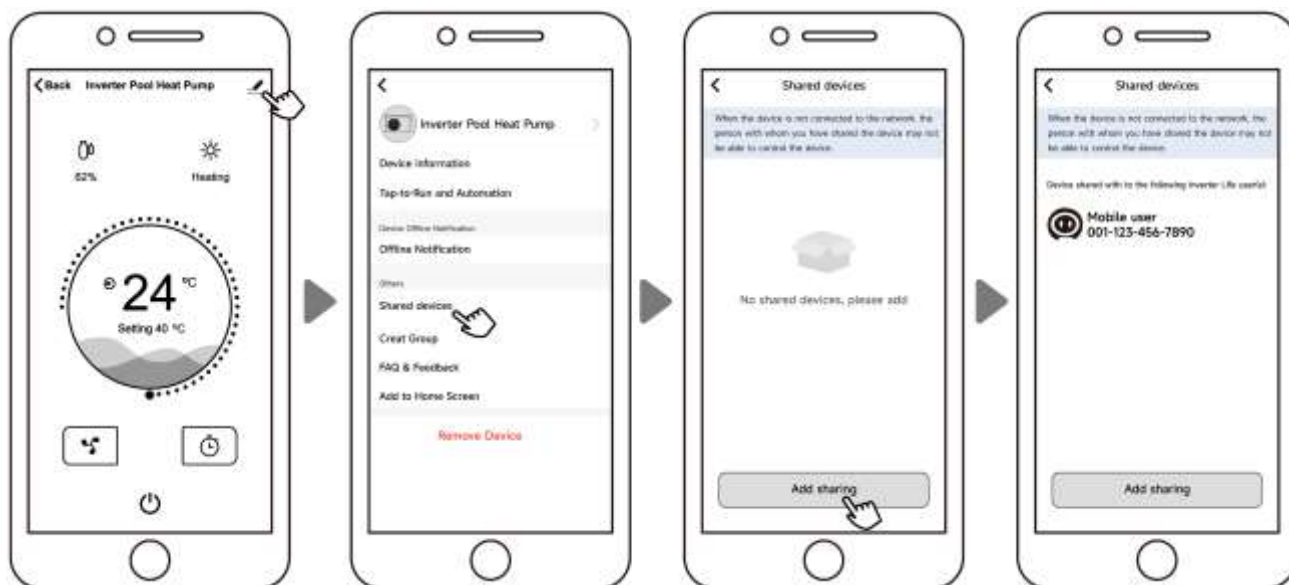

Once logged into the app, your family members will have visibility of this heat pump.

Notice: 1. The weather forecast is just for reference.

2. APP is subject to update without notice.

Control Fault Message Table

To assist in determining the cause of the error message, refer to the table below.

Code	Not Failure Description
E3	No water protection
E5	Power supply exceeds operation range
E6	Excessive temp difference between inlet and outlet water (Insufficient water flow protection)
Eb	Ambient temperature too high or too low protection
Ed	Anti-freezing reminder
OFF	Customer Control Switch DIN2 Disconnect
Code	Failure Description
E1	High pressure protection
E2	Low pressure protection
E4	Phases lack protection (three phase model only)
E7	Water outlet temp too high or too low protection
E8	High exhaust temp protection
EA	Evaporator overheat protection (only at cooling mode)
P0	Controller communication failure
P1	Water inlet temp sensor failure
P2	Water outlet temp sensor failure
P3	Gas exhaust temp sensor failure
P4	Heating (Evaporator) coil pipe temp sensor
P5	Gas return temp sensor failure
P6	Cooling (Titanium heat exchanger) coil pipe temp sensor
P7	Ambient temp sensor failure
P8	Cooling plate sensor failure
P9	Current sensor failure
PA	Restart memory failure
F1	Compressor drive module failure
F2	PFC module failure
F3	Compressor start failure
F4	Compressor running failure
F5	Inverter board over current protection
F6	Inverter board overheat protection
F7	Current protection
F8	Cooling plate overheat protection
F9	Fan motor failure
Fb	Capacitor no charging protection
FA	PFC module over current protection
8888	Communication failure

Troubleshooting

WIRING DIAGRAM - 1

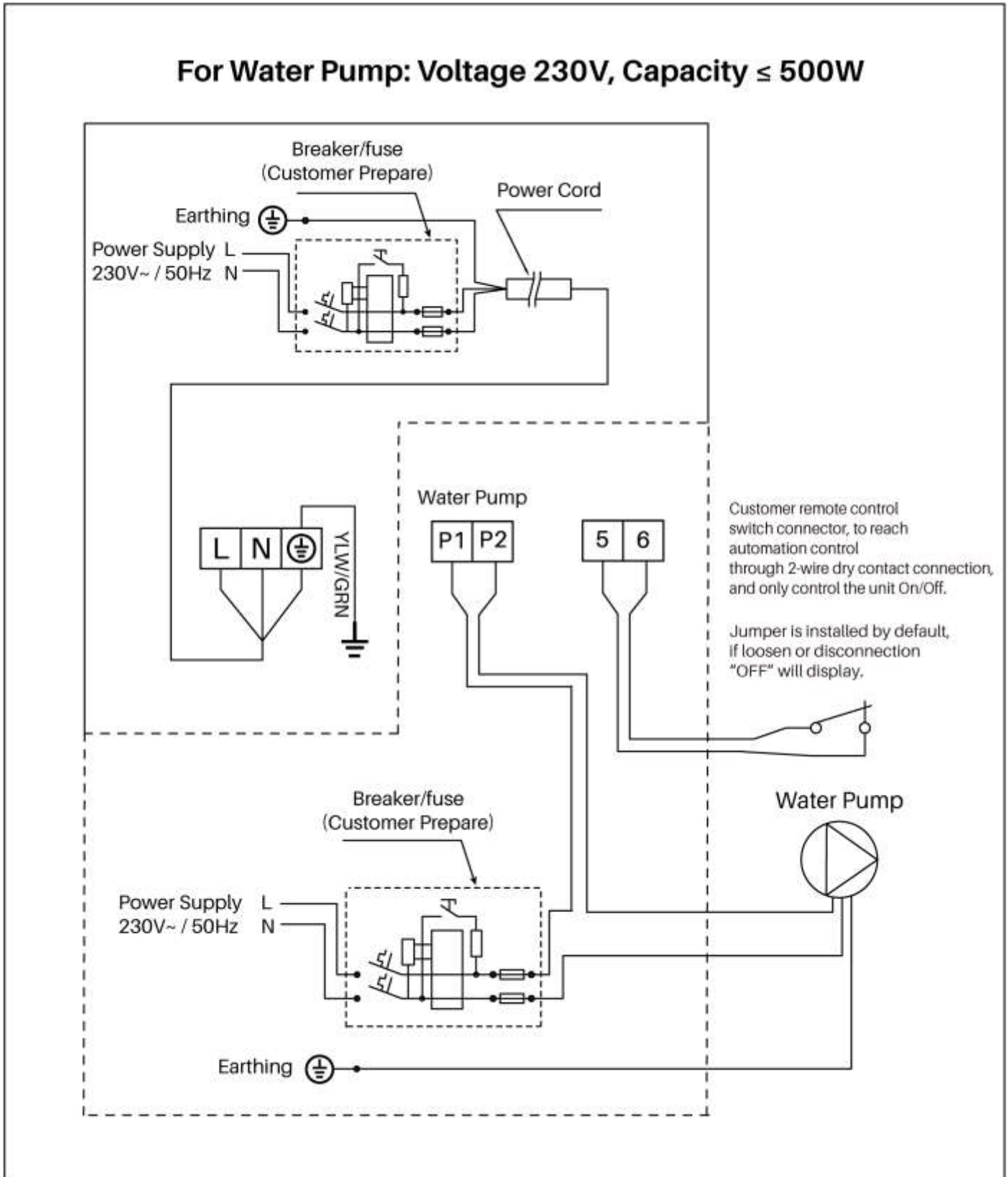

WIRING DIAGRAM - 2

For Water Pump: Voltage 230V, Capacity > 500W

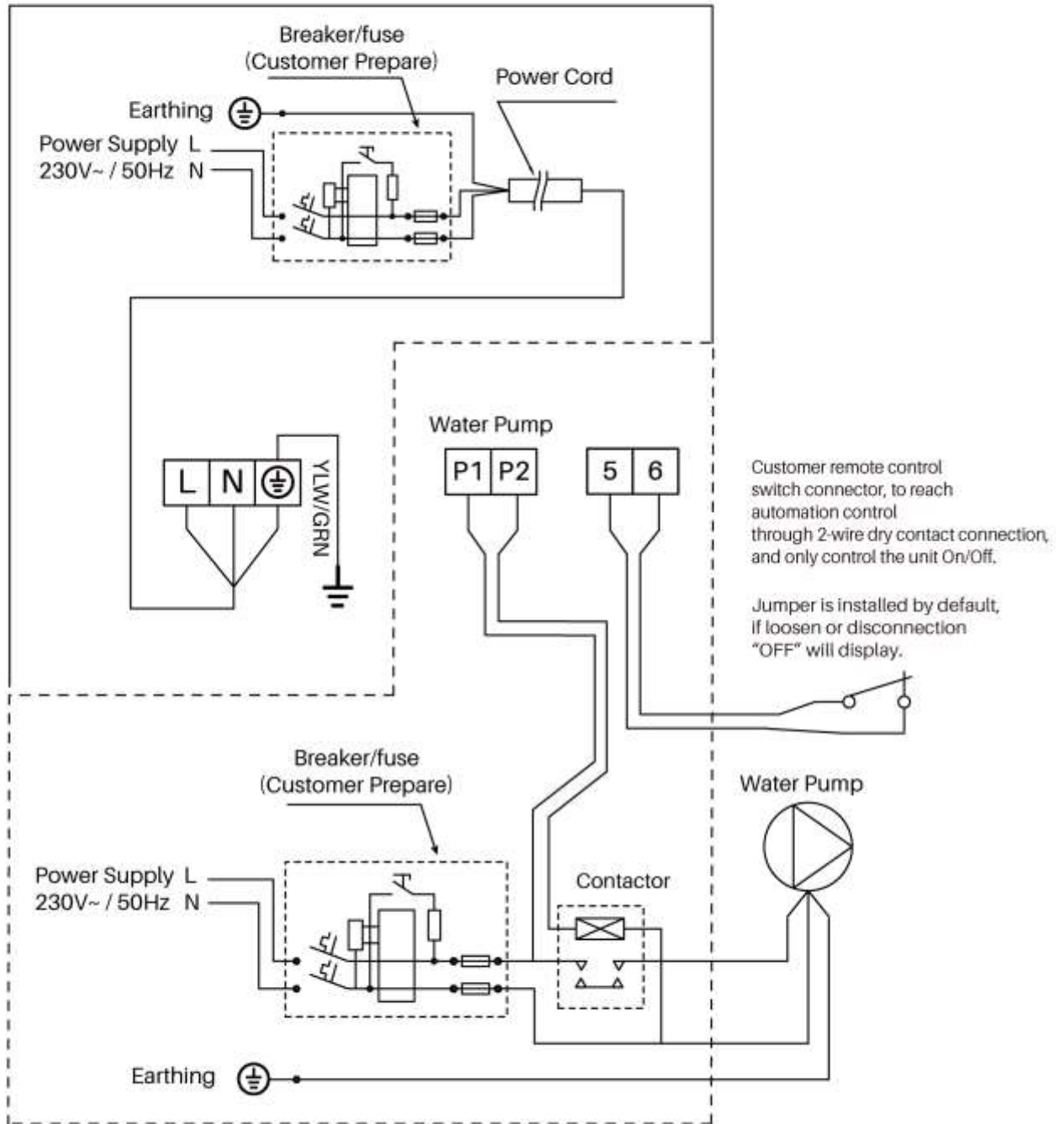

WIRING DIAGRAM - 3

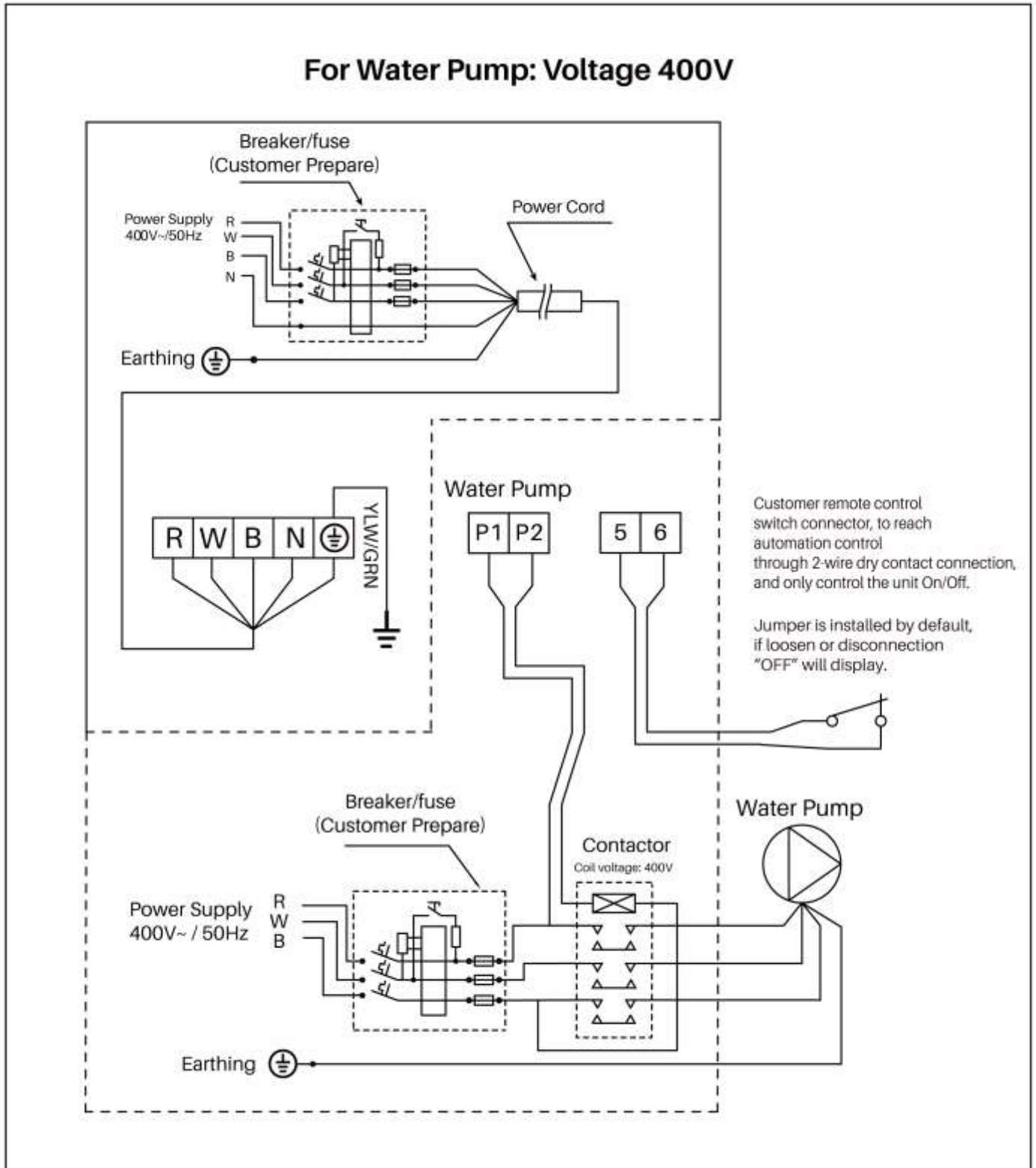

Troubleshooting

F.A.Q

 Do I need to have my heat pump serviced?

It is recommended that you have your Oasis heat pump serviced once per year by your local certified air conditioning or refrigeration technician. If your unit is located in a coastal area, more frequent maintenance may be necessary.

During the service, they will check the operational pressures of the refrigeration system and clean the fin coil to ensure maximum performance.

 Do we have recommended service agents?

Oasis have a large database of recommended service agents. Please contact us for your local service agent details.

 Should I check my unit regularly?

We recommend you check your unit regularly to avoid potential issues and damage to your heat pump.

 What should I be checking regularly?

Check the water inlet/outlets often for leaks. You should avoid the condition of no water or air entering into the system, as this will influence unit's performance and reliability.

You should clear the pool/spa filter regularly to avoid damage to the unit as a result of the dirty or clogged filter.

The area around the unit should be dry, clean and well ventilated. Make sure there is nothing blocking the airflow of the heater e.g. Leaf litter.

Check the power supply and cable connection often, should the unit begin to operate abnormally, switch it off and contact the qualified technician

Maintenance & Information

CHECKS TO THE AREA

Prior to beginning work on systems containing flammable refrigerants, safety checks are necessary to ensure that the risk of ignition is minimised. For repair to the refrigerating system, the following precautions shall be complied with prior to conducting work on the system. prolonged period of no usage.

WORK PROCEDURE

Work shall be undertaken under a controlled procedure to minimise the risk of a flammable gas or vapour being present while the work is being performed.

TRANSPORTATION

When storing or moving the heat pump, the heat pump should be at the upright position.

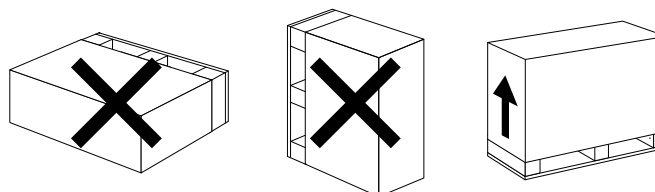

GENERAL WORK AREA

All maintenance staff and others working in the local area shall be instructed on the nature of work being carried out.

Work in confined spaces shall be avoided. The area around the workspace shall be sectioned off. Ensure that the conditions within the area have been made safe by control of flammable material.

CHECKING FOR PRESENCE OF REFRIGERANT

The area shall be checked with an appropriate refrigerant detector prior to and during work, to ensure the technician is aware of potentially flammable atmospheres. Ensure that the leak detection equipment being used is suitable for use with flammable refrigerants, i.e. non-sparking, adequately sealed or intrinsically safe.

PRESENCE OF FIRE EXTINGUISHER

If any hot work is to be conducted on the refrigeration equipment or any associated parts, appropriate fire extinguishing equipment shall be available to hand. Have a dry powder or CO₂ fire extinguisher adjacent to the charging.

NO IGNITION SOURCES

No person carrying out work in relation to a refrigeration system which involves exposing any pipe work that contains or has contained flammable refrigerant shall use any sources of ignition in such a manner that it may lead to the risk of fire or explosion. All possible ignition sources, including cigarette smoking, should be kept sufficiently far away from the site of installation, repairing, removing and disposal, during which flammable refrigerant can possibly be released to the surrounding space. Prior to work taking place, the area around the equipment is to be surveyed to make sure that there are no flammable hazards or ignition risks. No Smoking signs shall be displayed.

VENTILATED AREA

Ensure that the area is in the open or that it is adequately ventilated before breaking into the system or conducting any hot work. A degree of ventilation shall continue during the period that the work is carried out.

Maintenance & Information

CHECKS TO THE REFRIGERATION EQUIPMENT

Where electrical components are being changed, they shall be fit for the purpose and to the correct specification. At all times the manufacturer's maintenance and service guidelines shall be followed. If in doubt consult the manufacturer's technical department for assistance.

The following checks shall be applied to installations using flammable refrigerants:

- The charge size is in accordance with the room size within which the refrigerant containing parts are installed;
- The ventilation machinery and outlets are operating adequately and are not obstructed; If an indirect refrigerating circuit is being used, the secondary circuit shall be checked for the presence of refrigerant;
- Marking to the equipment continues to be visible and legible. Markings and signs that are illegible shall be corrected;
- Refrigeration pipe or components are installed in a position where they are unlikely to be exposed to any substance which may corrode refrigerant containing components, unless the components are constructed of materials which are inherently resistant to being corroded or are suitably protected against being so corroded.

CHECKS TO ELECTRICAL DEVICES

Repair and maintenance to electrical components shall include initial safety checks and component inspection procedures. If a fault exists that could compromise safety, then no electrical supply shall be connected to the circuit until it is satisfactorily dealt with. If the fault cannot be corrected immediately but it is necessary to continue operation, an adequate temporary solution shall be used. This shall be reported to the owner of the equipment, so all parties are advised.

Initial safety checks shall include:

- That capacitors are discharged: this shall be done in a safe manner to avoid possibility of sparking;
- That there no live electrical components and wiring are exposed while charging, recovering or purging the system;
- That there is continuity of earth bonding.

CABLING

Check that cabling will not be subject to wear, corrosion, excessive pressure, vibration, sharp edges or any other adverse environmental effects. The check shall also consider the effects of aging or continual vibration from sources such as compressors or fans.

REPAIR TO INTRINSICALLY SAFE COMPONENTS

Do not apply any permanent inductive or capacitance loads to the circuit without ensuring that this will not exceed the permissible voltage and current permitted for the equipment in use.

Intrinsically safe components are the only types that can be worked on while live in the presence of a flammable atmosphere. The test apparatus shall be at the correct rating. Replace components only with parts specified by the manufacturer. Other parts may result in the ignition of refrigerant in the atmosphere from a leak.

Maintenance & Information

REPAIRS TO SEALED COMPONENTS

- 1) During repairs to sealed components, all electrical supplies shall be disconnected from the equipment being worked upon prior to any removal of sealed covers, etc. If it is necessary to have an electrical supply to equipment during servicing, then a permanently operating form of leak detection shall be located at the most critical point to warn of a potentially hazardous situation.
- 2) Particular attention shall be paid to the following to ensure that by working on electrical components, the casing is not altered in such a way that the level of protection is affected. This shall include damage to cables, excessive number of connections, terminals not made to original specification, damage to seals, incorrect fitting of glands, etc.

Ensure that apparatus is mounted securely.

Ensure that seals or sealing materials have not degraded such that they no longer serve the purpose of preventing the ingress of flammable atmospheres. Replacement parts shall be in accordance with the manufacturer's specifications.

NOTE: The use of silicon sealant may inhibit the effectiveness of some types of leak detection equipment. Intrinsically safe components do not have to be isolated prior to commencing works.

DETECTION OF FLAMMABLE REFRIGERANTS

Under no circumstances shall potential sources of ignition be used in the searching for or detection of refrigerant leaks. A halide torch (or any other detector using a naked flame) shall not be used.

LEAK DETECTION METHODS

The following leak detection methods are deemed acceptable for systems containing flammable refrigerants.

Electronic leak detectors shall be used to detect flammable refrigerants, but the sensitivity may not be adequate, or may need re-calibration. (Detection equipment shall be calibrated in a refrigerant-free area.)

Ensure that the detector is not a potential source of ignition and is suitable for the refrigerant used. Leak detection equipment shall be set at a percentage of the LFL of the refrigerant and shall be calibrated to the refrigerant employed and the appropriate percentage of gas (25 % maximum) is confirmed.

Leak detection fluids are suitable for use with most refrigerants but the use of detergents containing chlorine shall be avoided as the chlorine may react with the refrigerant and corrode the copper pipe-work.

If a leak is suspected, all naked flames shall be removed/ extinguished.

If a leakage of refrigerant is found which requires brazing, all of the refrigerant shall be recovered from the system, or isolated (by means of shut off valves) in a part of the system remote from the leak. Oxygen free nitrogen (OFN) shall then be purged through the system both before and during the brazing process.

Maintenance & Information

REMOVAL AND EVACUATION

When breaking into the refrigerant circuit to make repairs or for any other purpose conventional procedures shall be used. However, it is important that best practice is followed since flammability is a consideration. The following procedure shall be adhered to:

- Remove refrigerant;
- Purge the circuit with inert gas;
- Evacuate;
- Purge again with inert gas;
- Open the circuit by cutting or brazing.

The refrigerant charge shall be recovered into the correct recovery cylinders. The system shall be "flushed" with OFN to render the unit safe. This process may need to be repeated several times. Compressed air or oxygen shall not be used for this task.

Flushing shall be achieved by breaking the vacuum in the system with OFN and continuing to fill until the working pressure is achieved, then venting to atmosphere, and finally pulling down to a vacuum. This process shall be repeated until no refrigerant is within the system. When the final OFN charge is used, the system shall be vented down to atmospheric pressure to enable work to take place. This operation is absolutely vital if brazing operations on the pipe-work are to take place.

Ensure that the outlet for the vacuum pump is not close to any ignition sources and there is ventilation available.

LABELLING

Equipment shall be labelled stating that it has been de-commissioned and emptied of refrigerant. The label shall be dated and signed. Ensure that there are labels on the equipment stating the equipment contains flammable refrigerant.

RECOVERY

When removing refrigerant from a system, either for servicing or decommissioning, it is recommended good practice that all refrigerants are removed safely.

When transferring refrigerant into cylinders, ensure that only appropriate refrigerant recovery cylinders are employed. Ensure that the correct number of cylinders for holding the total system charge is available. All cylinders to be used are designated for the recovered refrigerant and labelled for that refrigerant (i.e. special cylinders for the recovery of refrigerant). Cylinders shall be complete with pressure relief valve and associated shut-off valves in good working order. Empty recovery cylinders are evacuated and, if possible, cooled before recovery occurs.

The recovery equipment shall be in good working order with a set of instructions concerning the equipment that is at hand and shall be suitable for the recovery of flammable refrigerants. In addition, a set of calibrated weighing scales shall be available and in good working order. Hoses shall be complete with leak-free disconnect couplings and in good condition. Before using the recovery machine, check that it is in satisfactory working order, has been properly maintained and that any associated electrical components are sealed to prevent ignition in the event of a refrigerant release. Consult manufacturer if in doubt.

The recovered refrigerant shall be returned to the refrigerant supplier in the correct recovery cylinder, and the relevant Waste Transfer Note arranged. Do not mix refrigerants in recovery units and especially not in cylinders.

If compressors or compressor oils are to be removed, ensure that they have been evacuated to an acceptable level to make certain that flammable refrigerant does not remain within the lubricant. The evacuation process shall be carried out prior to returning the compressor to the suppliers. Only electric heating to the compressor body shall be employed to accelerate this process. When oil is drained from a system, it shall be carried out safely.

Maintenance & Information

DECOMMISSIONING

Before carrying out this procedure, it is essential that the technician is completely familiar with the equipment and all its detail. It is recommended good practice that all refrigerants are recovered safely. Prior to the task being carried out, an oil and refrigerant sample shall be taken in case analysis is required prior to re-use of reclaimed refrigerant. It is essential that electrical power is available before the task is commenced.

- a. Become familiar with the equipment and its operation.
- b. Isolate system electrically.
- c. Before attempting the procedure ensure that:
 - i. Mechanical handling equipment is available, if required, for handling refrigerant cylinders;
 - ii. All personal protective equipment is available and being used correctly;
 - iii. The recovery process is always supervised by a competent person;
 - iv. Recovery equipment and cylinders conform to the appropriate standards.
- d. Pump down refrigerant system, if possible.
- e. If a vacuum is not possible, make a manifold so that refrigerant can be removed from various parts of the system.
- f. Make sure that cylinder is situated on the scales before recovery takes place.
- g. Start the recovery machine and operate in accordance with manufacturer's instructions.
- h. Do not overfill cylinders. (No more than 80 % volume liquid charge).
- i. Do not exceed the maximum working pressure of the cylinder, even temporarily.
- j. When the cylinders have been filled correctly and the process completed, make sure that the cylinders and the equipment are removed from site promptly and all isolation valves on the equipment are close doff.
- k. Recovered refrigerant shall not be charged into another refrigeration system unless it has been cleaned and checked.

CHARGING PROCEDURES

In addition to conventional charging procedures, the following requirements shall be followed.

- Ensure that contamination of different refrigerants does not occur when using charging equipment. Hoses or lines shall be as short as possible to minimise the amount of refrigerant contained in them.
- Cylinders shall be kept upright.
- Ensure that the refrigeration system is earthed prior to charging the system with refrigerant.
- Label the system when charging is complete (if not already).
- Extreme care shall be taken not to overfill the refrigeration system.

Prior to recharging the system, it shall be pressure tested with OFN. The system shall be leak tested on completion of charging but prior to commissioning. A follow up leak test shall be carried out prior to leaving the site.

The safety wire model is 5*20_5A/250VAC, and must meet the explosion-proof requirements.

Technical Support and Warranty Requests



For all warranty enquiries please contact your local distributor or contact Oasis directly and we will direct you to your nearest authorised repairer for assistance.

- contact Oasis on 1800 815 913 or via our [Service Request](#) page on our web site;
- provide a copy of your invoice as proof of purchase;
- provide further information relating to the issue, including any photos or videos;
- have completed the online warranty registration or provide a completed warranty card.

OASIS

Ph: 09 535 8891

Website: oasisheatpumps.com/

Email: service@oasisheatpumps.com

Warranty

Governing New Zealand Consumer Law

Our goods come with guarantees that cannot be excluded under the New Zealand Consumer Law. You are entitled to a replacement or refund for a major failure and for compensation for any other reasonably foreseeable loss or damage. You are also entitled to have the goods repaired or replaced if the goods fail to be of acceptable quality and the failure does not amount to a major failure.

This Warranty applies to residential products purchased and installed in New Zealand ONLY.

Warranty Period

Your **Oasis Heat Pump** warranty commences from the date of purchase for the sole benefit of the original consumer and with respect to the original installation only (non-transferable under any circumstance)

25 Years	Titanium heat exchanger against corrosion <i>Casing of heat exchanger is covered for 2 years</i>
5 Years	Compressor
3 Years	Parts supply
1 Year	Labour completed by Oasis or its dedicated service agents

On Commercial Installations, such as but not exclusively health clubs, swim schools, motels / hotels and hydrotherapy, parts and in field labour warranty, the warranty period is limited to twelve (12) months only.

Warranty Coverage

During the Warranty Period, Oasis warrants that the Product will be free from material defects in materials and workmanship under normal use and maintenance.

This Warranty is subject to the terms and conditions set out hereunder.

- This warranty excludes any defect or injury caused by or resulting from misuse, abuse, neglect, accidental damage, improper voltage, vermin or insect infestation, incompetent installation, any fault not attributable to faulty manufacture or parts, any modifications which affect the reliability or performance of the unit.
- This Warranty does not cover any cost of labour after the initial period of 12 months from date of installation. Any labour cost incurred in the execution of this Warranty after this period is the sole responsibility of the Consumer.
- If a defect in materials or workmanship occurs within the warranty period Oasis will, at its discretion repair or replace product or the defective part of the product free of charge or cause the product or the defective part to be repaired or replaced by an Authorised Oasis Aquatics Service Agent free of charge.

Warranty

- Equipment defects covered by this Warranty will be repaired or replaced at the discretion of Oasis without cost to the owner for parts or direct repair labour. Should the buyer purchase parts / components from their own supplier, the company may at their own discretion reject or reimburse the cost to which the company can purchase the part for. The repair or replacement shall be performed during normal business hours by authorized technical service agents or Oasis. Service outside the normal operating area will incur a traveling fee.
- Oasis reserves the right to substitute defective parts or the product with parts or product of similar quality, grade and performance where an identical part or product is not available. Parts or products may be replaced by refurbished goods of the same type rather than be repaired.
- The company does not assume nor permits any person to assume any additional liabilities in relation to the sale of this equipment on its behalf.
- No employee, agent or representative of Oasis Heating nor the Buyer has any authority to vary the terms of this Warranty

This warranty does not cover the following:

- a. Natural Disasters (hail, lightning, flood, fire etc.)
- b. Rust or damage to paintwork caused by a corrosive atmosphere.
- c. When a unit is installed by an unqualified person.
- d. Where a unit is incorrectly installed.
- e. When failure occurs due to improper or faulty installation.
- f. Damage or problems caused by the use of an accessory, component or equipment not approved by Oasis
- g. When serviced by an unauthorized person without the permission of Oasis.
- h. Failure due to improper maintenance.
- i. Equipment which has been re-installed at a location other than the original location.
- j. 'No Fault Found' service calls where the perceived problem is explained within the operation instructions.
- k. Costs associated with delivery, handling, freight, or damage to the product in transit.
- l. Items that are replaced as part of routine maintenance.
- m. Damage, problems or unsatisfactory performance resulting from misapplication of the equipment.

Definitions

"Buyer" refers to the person or entity who initially purchases equipment from Oasis Heat Pumps Ltd

"Company" refers to Oasis Heat Pumps Ltd

"Equipment" or "Goods" specifically refer to the Heat Pump.

"Purchaser" is the individual or organization who buys the Heat Pump for their own use as a consumer or end user.

Warranty

Owner's Responsibility

Proper operation and regular maintenance of the equipment are the responsibility of the owner, and should be carried out according to the recommended time and frequency specified in the manual to avoid voiding the warranty. The correction of any non-product fault or problem is not covered by this warranty.

Disclaimer

Information in this guide is intended to provide general information on a particular subject(s) in good faith and is not an exhaustive treatment of such subject(s). Its use is beyond the control of the author, contributor, publishers and distributors and should not be relied upon without consulting your local Professional for comprehensive advice.

This guide includes subject(s) that should only be performed by or under the direction and advice of your local professional and under no circumstances should the guide be used as a substitute for such professionals.

No representations or warranties are made that the content, advice and recommendations in this guide are current, free from errors or omissions, or appropriate for the user's circumstances or abilities. No liability or responsibility is accepted for any loss suffered as a result of any user's reliance on such content.



Notes



For inquiries, contact us.



Oasisheatpumps.com

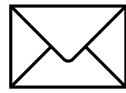

service@oasisheatpumps.com

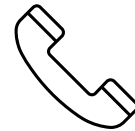

09 535 8891



New Zealand

Oasis Heat Pumps
Unit 1, 4 Antares Place
Rosedale, Auckland 0632
Phone: 09 535 8891

Head Office

6-8 Austral Place
Hallam VIC 3803
Phone: 03 9887 2131

New South Wales

Unit 2, 10 Boden Road
Seven Hills NSW 2147
Phone: 02 9838 0000

Queensland

11 Andy Court
Upper Coomera QLD 4209
Phone: 07 5679 6821